



# Start-Up and Service Instructions

## CONTENTS

	Page
<b>START-UP</b> .....	1
<b>SERVICE</b> .....	1,2
General Notes .....	1
Compressor Replacement .....	2
<b>SAFETY REMINDERS</b> .....	2
<b>PREVENTIVE MAINTENANCE</b> .....	2-4
General .....	2
System Cleaning/Flushing .....	2
<b>DISASSEMBLY INFORMATION</b> .....	5-12
Filter Removal .....	5
Front Grille Removal .....	5
Control Box Removal .....	5
Thermostat Bulb Heater Removal .....	7
Mode Switch Control Removal .....	7
Timer Assembly Removal (Models 73YCA213P and 73YCA243P Only) .....	7
Capacitor Removal .....	7
Indicator Light Removal (Models 73YCA213P and 73YCA243P Only) .....	8
Indoor Thermostat Removal .....	8
Fan Cycle Switch (Energy Saver Switch) Removal .....	8
Air Sweep Switch Removal (Models 73YCA213P and 73YCA243P Only) .....	8
Chassis Removal .....	8
Air Sweep Motor Removal (Models 73YCA213P and 73YCA243P Only) .....	8
Evaporator and Condenser Coils Removal .....	8
Air Handling System Removal .....	9
Exhaust Door Removal .....	9
Vent Door Removal (Models 73YCA213P and 73YCA243P Only) .....	9
Indoor Blower Wheel Removal .....	10
Outdoor Propeller Fan Removal .....	10
Fan Motor Removal .....	11
Compressor Removal .....	11
Strainer Removal and Replacement .....	11
Electric Heater Assembly Removal .....	11
<b>SERVICE POINTS</b> .....	13
<b>TROUBLESHOOTING</b> .....	14

## START-UP

Refer to operating instructions in Owner's Guide provided with room air conditioner

## SERVICE

**General Notes** — These Start-Up and Service Instructions are provided to assist the trained and qualified service technician in repairing or replacing components of Carrier room air conditioner model offerings for 1993. These instructions contain disassembly photos for the Models 73XC,XH, and YC. Unit physical data is found in Tables 1-9.

**IMPORTANT:** Repairing and servicing air conditioners can be hazardous for untrained individuals. The instructions printed in this publication are for properly trained and qualified Carrier service technicians only.

### ⚠ WARNING

Before working on any air conditioner, be sure to first disconnect all electric power to the unit to avoid the possibility of electrical shock and personal injury.

Discharge capacitors before disconnecting, by shorting across terminals.

Shield coils with cardboard to protect hands against injury from sharp metal edges when removing compressor and other components.

When disassembling wiring, use numbered stickers to identify wire leads and terminals. This aids in quick, accurate reassembly.

Check clearances around scroll and housing before installing fans. Before securing fan(s) fasteners, rotate fan by hand to ensure ample clearance.

Refer to Carrier Standard Service Techniques, Chapters 1 and 2, for information on checking motors; removing refrigerant; adding oil; and evacuating, dehydrating, and charging system. Pay particular attention to all safety warnings for these procedures.

**NOTE:** In Carrier Standard Service Techniques, refrigerant removal must always include reclaiming the refrigerant, not allowing it to escape to the atmosphere.

**Compressor Replacement** — Stand clear of compressor terminals when working on compressors. With system under pressure, terminals may blow. Observe the same safety procedures for rotary compressors as for reciprocating compressors.

When changing compressors:

1. Follow all safety codes. Reminder: use protective goggles, work gloves, and water-soaked quenching cloth
2. Shut off all electrical power to unit by removing power cord from outlet, then disconnect all wiring from the compressor.
3. Apply field-supplied tap-a-lines to the true (closest to compressor) suction and discharge connections of the compressor.
4. Recover the refrigerant charge from the unit. After recovering, cut the discharge and suction line process tubes below the tube crimps. If you choose a good tubing location for cutting the refrigerant lines initially, the location is easily accessible when making the final joints. You can braze the oil piping stub into the new compressor fittings more easily *before* the compressor is put back into the unit.

#### **▲ CAUTION**

Oil vapor in piping stubs can ignite from torch flame and cause serious injury. Exercise extreme care when brazing, and keep brazing cloth and fire extinguisher handy for emergency use.

5. Connect a nitrogen supply to the unit at one of the tap-a-line connectors (5 psig maximum flow), leaving the other connector open to the atmosphere. Braze angle valves with stubs to each process tube.
6. Remove compressor from unit. Refer to Compressor Removal, page 11.
7. Remove tap-a-lines from suction and discharge lines. Carefully braze the holes closed from where the tap-a-lines were removed.
8. Clean system: add or replace liquid line filter drier. For proper cleaning and flushing, use the Carrier Totalclaim® reclaim system or a comparable refrigerant recycling system.
9. Install new compressor and braze into place with field-supplied copper slip couplings.
10. Connect wiring: replace wire terminals if necessary.
11. Proceed with evacuation and charging. Pinch off lines where angle valves were added. Cut off angle valves above pinch-off, and braze tubes.
12. Start up unit.

## **SAFETY REMINDERS**

1. Carry a fire extinguisher in your truck. Keep it within reach when using a torch. Check fire extinguisher periodically to be sure it is fully loaded and functional.
2. Know how to handle oxyacetylene equipment safely. Lock the equipment in an upright position in the truck and at the job site.
3. Use dry nitrogen or carbon dioxide to pressurize the system for leak checking. Always use a good regulator. Be careful not to exceed 150 psig test pressure in the hermetic compressor.
4. Wear safety goggles and gloves when recovering refrigerant from a system.
5. Attend shop safety meetings.

## **PREVENTIVE MAINTENANCE**

### **General**

**CLEANING** — Clean cooling coil and condenser coil. Hold flashlight behind coil to see if all spaces are clear. Use a hooked wire to remove dirt. Dust accumulation obstructs or reduces airflow and results in loss of capacity. Coils may be vacuumed when dry. Outdoors, unit can be brushed with a stiff brush and fins blown out with compressed air.

Thoroughly clean basepan, motors, fan wheels, other components, and all drain passages. Vacuum insulation. Clean all inside painted surfaces with mild detergent to remove grease.

Clean cabinet and grille. Mild detergents reduce electrostatic charges on plastic sections of the grille and are good cleaners. *Do not use* carbon tetrachloride, solvents, or waxes containing solvents to clean plastic sections.

**PAINTING** — Paint any parts that show evidence of rust with a good rust-resistant paint.

**WIRING** — Check all wiring for deterioration and all electrical contacts for tightness and lack of corrosion.

**MOUNTING** — Make sure unit is secure in window, and level from left to right and from front to rear according to installation instructions provided.

Check fans to ensure they are correctly positioned, centered in orifice, and tight on shaft.

**LEAKS** — Check any connections that show evidence of oil or leaks. When unit is properly installed, centered, and leveled (see Owners' Guide), check gaskets and wing panels for possible air leakage.

**CONTROLS** — Check unit to ensure all controls are functioning correctly and unit operation is normal.

Vibrations can cause unwanted noise. Check to be sure no piping is vibrating against any side of unit.

**System Cleaning/Flushing** — For proper cleaning and flushing, use the Carrier Totalclaim reclaim system, or a comparable refrigerant recycling system.

**Table 1 – Physical and Electrical Data (Single Phase, 60 Hz) – 1993**

MODEL 73	CASING (See Table 6)	CAPACITY (Btuh)*		R-22 CHG (oz. ± .05)	WET BULB Δt F	NAMEPLATE						EER (DOE)	PF (%)
		Cooling	Heating			Volts	Voltage Range	Amps		Watts			
								Cool	Heat	Cool	Heat		
XHA101D	305	9,100	5,200	29.5	10.3	115	127-104	9.0	16.1	1020	1840	9.0	98
XCA121D	305	12,000	—	37.5	10.0	115	127-104	10.5	—	1200	—	10.2/10.2	98/99
XCA123D	305	12,000/11,600	—	37.5	12.5	230/208	253-187	5.2/ 5.5	—	1180/1140	—	10.2/10.2	98/99
XHA123D	305	12,000/11,600	9,200/ 7,600	37.5	12.5	230/208	253-187	5.2/ 5.5	13.4/12.3	1180/1140	3080/2540	10.2/10.2	98/99
XCA153D	305	15,000/14,700	—	38	24.1	230/208	253-187	6.5/ 7.0	—	1470/1440	—	10.2/10.2	97/99
XHA153D	305	15,000/14,700	14,600/11,800	38	9.7	230/208	253-187	6.5/ 7.0	20.9/19.0	1470/1440	4790/3950	10.2/10.2	98/99
XHA173D	305	17,100/16,700	16,300/12,900	38	9.7	230/208	253-187	7.9/ 8.5	22.7/20.8	1800/1750	5220/4320	9.5/ 9.5	99/98
XCA183D	305	17,800/17,500	—	38	24.6	230/208	253-187	8.2/ 8.9	—	1870/1840	—	9.5/ 9.5	99/99
YCA213D	405	21,000/20,800	—	47	21.8	230/208	253-187	10.4/11.3	—	2290/2260	—	9.2/ 9.2	96/96
YCA213P	405	21,000/20,800	—	47	21.8	230/208	253-187	10.4/11.3	—	2290/2260	—	9.2/ 9.2	96/96
YCA243D	405	23,500/23,000	—	51	24.1	230/208	253-187	12.0/12.7	—	2670/2610	—	8.8/ 8.8	97/99
YCA243P	405	23,500/23,000	—	51	24.1	230/208	253-187	12.0/12.7	—	2670/2610	—	8.8/ 8.8	97/99

MODEL 73	CAPACITOR (See Table 5)	FAN MOTOR		COMPRESSOR (See Table 2)	THERMISTOR (See Table 4)	HEATER ASSEMBLY (See Table 3)	CAPILLARY (See Tables 7 and 8)		
		Carrier Part Number	FLA				Data	Insertion	Number of Tubes
XHA101D	RC-1	25901023	1.88	H-1	Z-1	V1	CD-4	CI-1	1
XCA121D	RC-1	25901023	1.88	H-2	Z-1	—	CD-6	CI-1	2
XCA123D	RC-1	25901026	0.98	H-3	Z-1	—	CD-6	CI-1	2
XHA123D	RC-1	25901026	0.98	H-3	Z-1	V2	CD-6	CI-1	2
XCA153D	RC-1	25901031	0.99	D-1	Z-1	—	CD-1	CI-1	3
XHA153D	RC-1	25901031	0.99	D-1	Z-1	V3	CD-1	CI-1	3
XHA173D	RC-2	25901018	1.24	D-3	Z-1	V4	CD-3	CI-1	3
XCA183D	RC-2	25901018	1.24	D-3	Z-1	—	CD-3	CI-1	3
YCA213D	RC-2	25901024	1.54	D-2	Z-1	—	CD-2	CI-1	3
YCA213P	RC-2	25901024	1.54	D-2	Z-1	—	CD-2	CI-1	3
YCA243D	RC-3	25901024	1.54	T-1	Z-1	—	CD-5	CI-1	3
YCA243P	RC-3	25901024	1.54	T-1	Z-1	—	CD-5	CI-1	3

LEGEND

- AHAM — Association of Home Appliance Manufacturers
- ANSI — American National Standards Institute
- DOE — Department of Energy
- EER — Energy Efficiency Ratio
- FLA — Full Load Amps
- PF — Power Factor

\*Based on AHAM Standard RAC-1 and ANSI Z234.1

Δt — Entering wet-bulb temperature minus leaving wet-bulb temperature based on 67 F room wet-bulb temperature and 95 F dry-bulb outside-air temperature. If conditions vary, wet-bulb Δt will vary.

**Table 2 – Compressors**

KEY NUMBER (See Table 1)	REPLACEMENT PART NUMBER	OIL RECHARGE (oz.)	VOLTS (1 Ph, 60 Hz)	LRA	FLA
D-1	P033-1521	13.0	230/208	33.2	5.9
D-2	P033-2221	23.0	230/208	50.0	9.1
D-3	P033-1821	13.0	230/208	38.0	7.4
H-1	P031-1004	9.1	115	48.3	8.6
H-2	P031-1103	9.1	115	54.0	16.0
H-3	P031-1122	9.1	230/208	26.3	4.8
T-1	P035-2522	18.3	230/208	63.0	10.7

LEGEND

- LRA — Locked Rotor Amps
- FLA — Full Load Amps

**Table 3 – Heater Assemblies**

HEATER ASSEMBLY (See Table 1)	KILOWATTS	PRIMARY LS (F)	SECONDARY LS (F)
V1	1.6	140	200
V2	2.8	140	200
V3	4.5	140	200
V4	5.0	140	210

LS – Limit Switch

**Table 4 – Thermistor**

KEY NUMBER (See Table 1)	CARRIER NUMBER	VENDOR NUMBER	RESISTANCE (Ohms)
Z-1	42320001	CM305C20C	25

**Table 5 – Capacitor**

KEY NUMBER (See Table 1)	CARRIER NUMBER	MFD	VOLTS
RC-1	05706028	25/5	370
RC-2	05706030	30/5	370
RC-3	05706031	45/5	370

**Table 6 – Casing Dimensions (in)**

KEY NUMBER (See Table 1)	HEIGHT	WIDTH	DEPTH
305	16 <sup>3</sup> / <sub>4</sub>	25 <sup>5</sup> / <sub>16</sub>	23 <sup>3</sup> / <sub>4</sub>
405	17 <sup>7</sup> / <sub>16</sub>	26	27 <sup>9</sup> / <sub>16</sub>





**Table 7 – Capillary Data**

KEY NUMBER (See Table 1)	DIMENSIONS (in.)	
	Length (± .002)	ID (± .002)
CD-1	1 Tube – 47.0	1 Tube – .054
	2 Tubes – 64.0	2 Tubes – .054
CD-2	2 Tubes – 29.3	2 Tubes – .054
	1 Tube – 56.3	1 Tube – .064
CD-3	1 Tube – 47.0	1 Tube – .054
	2 Tubes – 29.3	2 Tubes – .054
CD-4	1 Tube – 28.7	1 Tube – .064
CD-5	1 Tube – 39.5	1 Tube – .054
	2 Tubes – 29.3	2 Tubes – .054
CD-6	2 Tubes – 40.5	2 Tubes – .054

**Table 8 – Capillary Insertion**

KEY NUMBER (See Table 1)	DEPTH (in.)	DEPTH (in.)
	Condenser Coil Connection Tube	Evaporator Coil Connection Tube
CI-1	1	1

**Table 9 – Receptacles, Fuse Types, Wire Sizes**

UNIT NAMEPLATE VOLTAGE	115		230/208		
	12	16	12	16	24
MAXIMUM NAMEPLATE AMPS	12	16	12	16	24
OUTLET RATED VOLTS/AMPS	125/15	125/20	250/15	250/20	250/30
RECEPTACLE CONFIGURATION					
MFR PART NO.	5261	5361	5661	5461	9330
Hubbell	6201	5361	5661	5871	5930
P & S	GE5261-1	GE4102-1	GE4069-1	GE4182-1	GE4139-3
GE	5261	5361	5661	5861	5700
Arrow-Hart					
TIME-DELAY FUSE OR CIRCUIT BREAKER SIZE (AMPS)	15	20*	15	20*	30
FUSE TYPE		Plug		Cartridge	
RECOMMENDED AWG WIRE SIZE†	14	12	14	12	10

AWG – American Wire Gage

\*May be used for 15-amp applications if fused for 15-amp.

†Based on copper wire at 60 C temperature rating.

## DISASSEMBLY INFORMATION

### ⚠ WARNING

Before working on any air conditioner, be sure to first disconnect all electric power to unit to avoid the possibility of electrical shock and personal injury.

Models 73X,Y Room Air Conditioners have the following characteristics:

UNIT	FUNCTION	CASING
73XC	Cooling Only	305
73XH	Heat/Cool	305
73YC	Cooling Only	405

All units have a slide-out chassis. Units can be serviced without removing casing.

### Filter Removal

1. Place index fingers inside the openings on either side of the filter frame. See Fig. 1.
2. Apply pressure inward toward the center, while pulling filter down and out.
3. Vacuum filter, or wash in lukewarm water. Shake off excess water and dry thoroughly.
4. Replace filter by sliding filter upward behind front grille until filter snaps in place.

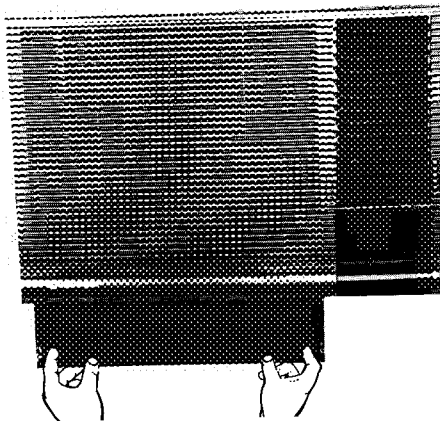

Fig. 1 – Removing Filter

### Front Grille Removal

1. Remove 2 screws located on either side of front grille. See Fig. 2.  
NOTE: Facing the front of unit, grille screw on the right-hand side serves as a unit security screw.
2. Pull grille out and upward, removing it from chassis. See Fig. 3.
3. To replace grille, place grille top on unit top edge and firmly press grille back into position.
4. Replace screws.

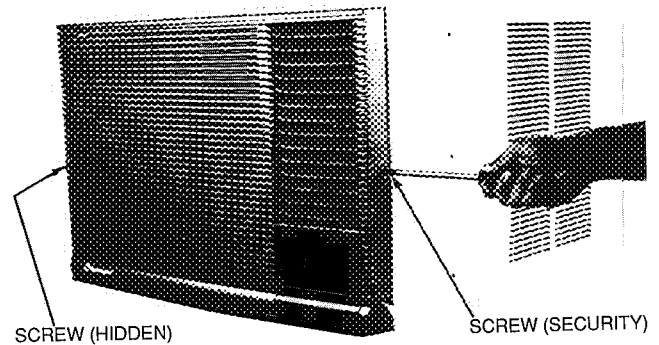

Fig. 2 – Removing 2 Screws from Front Grille

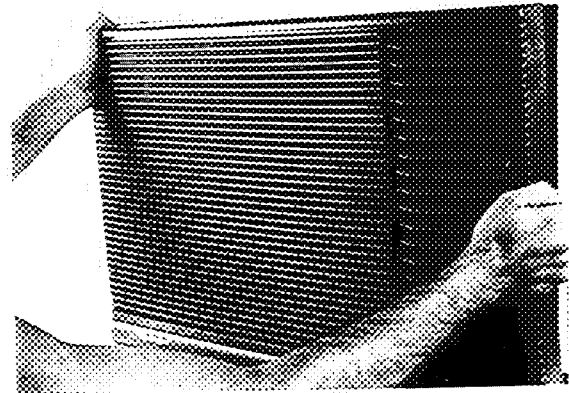

Fig. 3 – Removing Front Grille

### Control Box Removal

1. Slide chassis part way out of casing to access control box.

### ⚠ CAUTION

Use care when sliding chassis out of unit so that it does not fall from casing. Personal injury and/or damage to unit and surroundings can result.

NOTE: Sliding chassis partly out of casing ensures that the wiring does not become pinched when the control box is replaced. See Fig. 4.

2. Remove front grille. Refer to Front Grille Removal on this page.
3. Carefully remove thermostat and mode switch control knobs by pulling them straight out and off. See Fig. 5.
4. Grasp escutcheon located in lower right-hand corner of unit and apply pressure on both sides towards the center. See Fig. 6. Carefully disengage escutcheon plastic tabs from sheet metal slots and remove.
5. Remove 2 screws securing control box to chassis. See Fig. 7.
6. Disengage plastic clip, then remove sensing bulb with attached bulb heater from coil face. See Fig. 7.

7. Carefully pull control box straight out from unit.
8. On right side and bottom of control box, manually disengage removable sheet metal panel to access control box components. See Fig. 8. See Fig. 9 for control box components.
9. Reverse above procedure for reassembly, taking care not to pinch any wiring inside the control box. This is accomplished by guiding the wiring from the rear of the control as shown in Fig. 4.

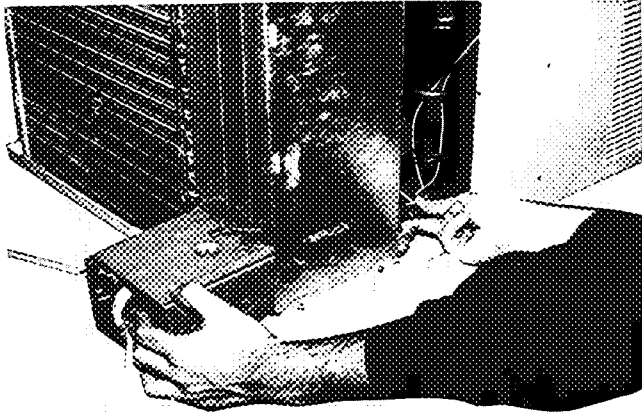

**Fig. 4 – Removing Control Box**

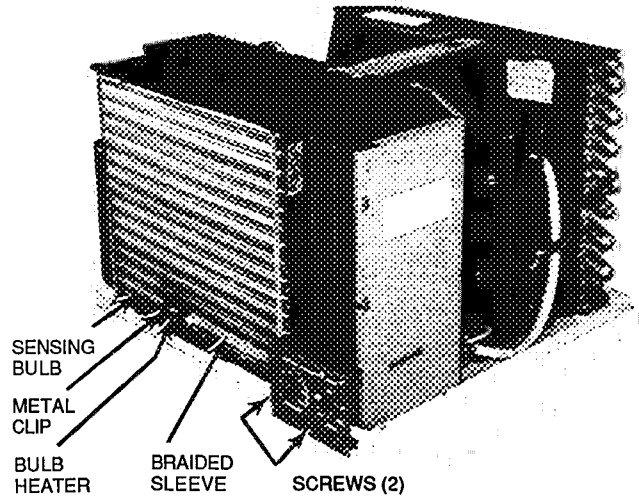

**Fig. 7 – Removing Screws Securing Control Box to Chassis**

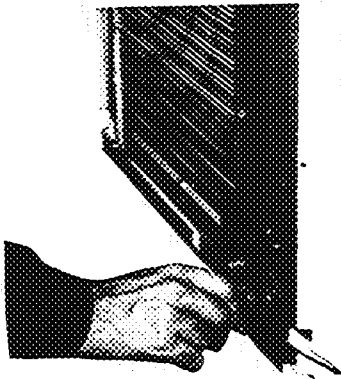

**Fig. 5 – Removing Knobs**

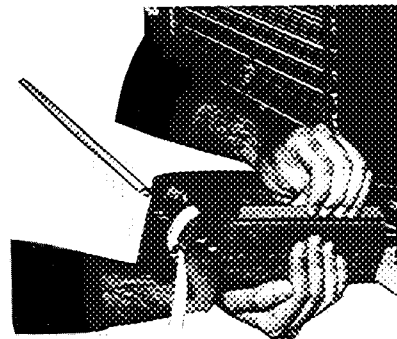

**GRASP PANEL**

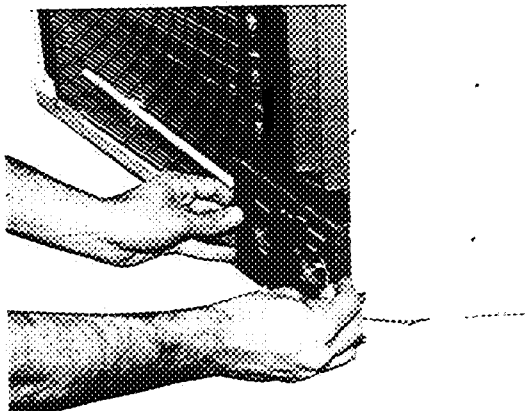

**Fig. 6 – Removing Escutcheon**

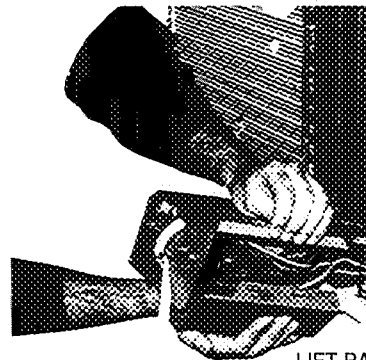

**LIFT PANEL TO REMOVE**

**Fig. 8 – Removing Sheet Metal Panel**

**Thermostat Bulb Heater Removal** — Use care not to damage sensing bulb or capillary of thermostat when handling bulb heater. See Fig. 7.

1. Slide out control box. Refer to Control Box Removal instructions, page 5.
2. Carefully disconnect bulb heater wires from terminals inside control box. Label wires to aid in reassembly.
3. Remove plastic clip used to hold thermostat sensing bulb, bulb heater, and braided sleeve to coil. (See Fig. 7.)
4. Carefully remove metal clip which connects bulb heater to sensing bulb.
5. Carefully remove bulb heater wires from braided sleeve (Fig. 7).
6. Reverse above procedure for reassembly.

**Mode Switch Control Removal (See Fig. 9 and 10)**

1. Slide out control box. Refer to Control Box Removal instructions, page 5.
2. Remove 2 screws holding mode switch control to control box. See Fig. 11.
3. Carefully disconnect wires from mode switch control. Label wires to aid in reassembly.
4. Reverse above procedure for reassembly.

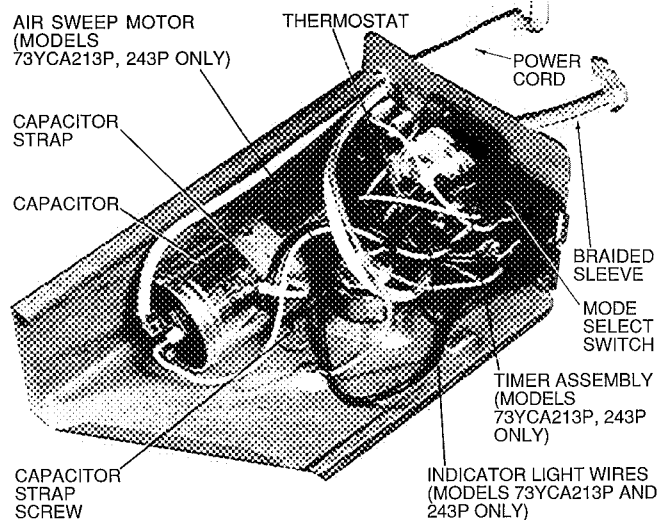

**Fig. 9 — Control Box Components**

**Timer Assembly Removal (Models 73YCA213P and 73YCA243P Only)**

1. Slide out control box. Refer to Control Box Removal instructions, page 5.
2. Carefully disconnect wires from timer assembly (Fig. 9). Label wires to aid in reassembly
3. Remove 2 screws securing timer to control box and remove timer from rear of control box.
4. Reverse procedure for reassembly.

**Capacitor Removal**

1. Discharge capacitor before removing.
2. Slide out control box. Refer to Control Box Removal instructions, page 5.
3. Remove screw fastening capacitor strap to control box and remove strap. (See Fig. 9, 10 and 12.)
4. Carefully disconnect wires from capacitor terminals. Label wires to aid in reassembly.
5. Reverse above procedure for reassembly.

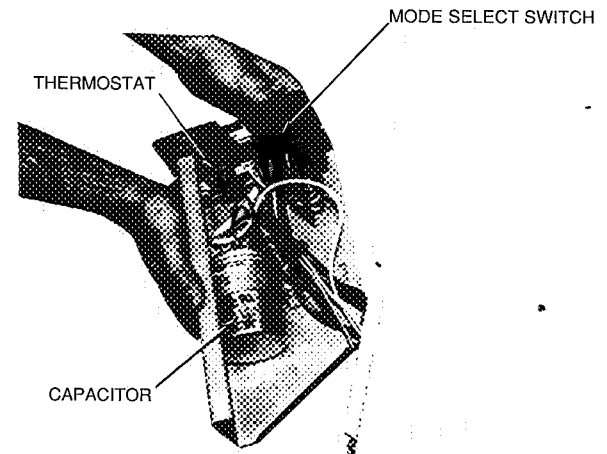

**Fig. 10 — Components Layout**

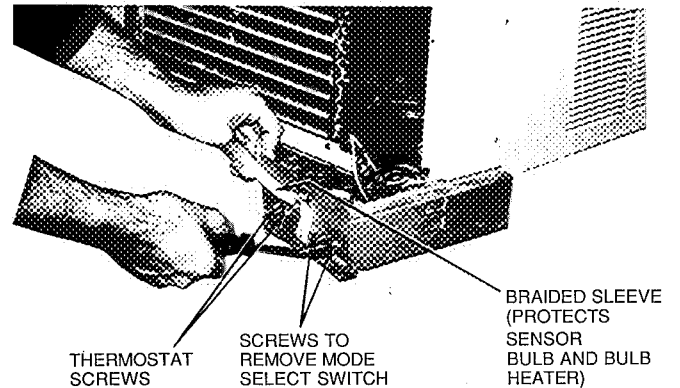

**Fig. 11 — Removing Thermostat and Bulb Heater**

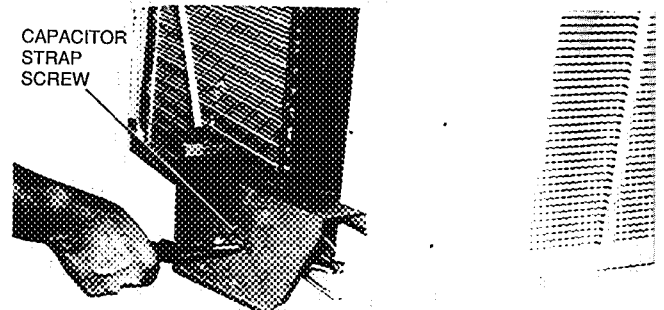

**Fig. 12 — Removing Capacitor Strap Screw**

### Indicator Light Removal (Models 73YCA213P and 73YCA243P Only)

1. Slide out control box. Refer to Control Box Removal instructions, page 5.
2. Carefully disconnect indicator light wires (Fig. 9 and 13) from termination connections. Label wires to aid in reassembly.
3. Remove light by pulling straight out through front of control box.
4. Reverse above procedure for reassembly.

**Indoor Thermostat Removal** — Indoor thermostat is a vapor-filled device with an attached bulb heater. Be careful not to bend or kink the thermostat-sensing bulb or capillary. See thermostat location in control box in Fig. 10.

1. Slide out control box. Refer to Control Box Removal instructions, page 5.
2. Remove 2 screws securing thermostat to control. See Fig. 11.
3. Carefully disconnect wires from thermostat terminals. Label wires to aid in reassembly.
4. Remove plastic clip used to hold bulb heater, sensing bulb, and braided sleeve to coil. (See Fig. 7.)
5. Remove metal clip which connects bulb heater to sensing bulb. (See Fig. 7.)
6. Carefully slide sensing bulb from protective sleeve. It is not necessary to remove the bulb heater from the braided sleeve.
7. Remove thermostat from control box.
8. Reverse above procedure for reassembly.

### Fan Cycle Switch (Energy Saver Switch) Removal

1. Slide out control box. Refer to Control Box Removal instructions, page 5.
2. Disconnect wires from switch. Label wires to aid in reassembly.
3. Remove 2 screws securing fan cycle switch (Fig. 13) and remove switch.
4. Reverse above procedure for reassembly.

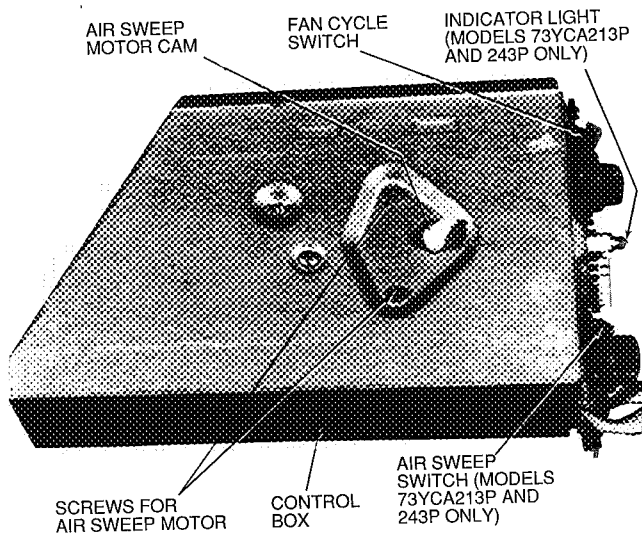

**Fig. 13 — Removing Air Sweep Motor**

### Air Sweep Switch Removal (Models 73YCA213P and 73YCA243P Only)

1. Slide out control box. Refer to Control Box Removal instructions, page 5.
2. Disconnect wires from switch. Label wires to aid in reassembly.
3. Remove 2 screws securing air sweep switch (Fig. 13) and remove switch.
4. Reverse above procedure for reassembly.

### Chassis Removal

#### ▲ CAUTION

Coil fins are sharp. Use care when removing chassis from casing to avoid personal injury. Do not use plastic parts for lifting or pulling. They are not structural members of the chassis. Lift using basepan only. Chassis is heavy. Obtain assistance for lifting.

Chassis can be serviced without removing unit casing from window or wall location.

1. Remove front grille. See Front Grille Removal instructions, page 5.
2. Slide chassis out of casing. See Fig. 14.
3. Reverse above procedure to reinstall chassis in casing. Be sure to replace and tighten left-hand screw and right-hand security screw on the front grille.

### Air Sweep Motor Removal (Models 73YCA213P and 73YCA243P Only)

1. Remove control box. See Control Box Removal instructions, page 5.
2. Carefully disconnect air sweep motor (Fig. 9) wire terminations.
3. Carefully pull plastic air sweep motor cam from shaft. See Fig. 13.
4. Remove 2 screws securing air sweep motor to control box and remove motor.
5. Reverse above procedure for reassembly.

### Evaporator and Condenser Coils Removal (See Fig. 15)

NOTE: Coils and interconnecting tubing are copper.

1. Reclaim all refrigerant from system using a Carrier Totalclaim® or Carrier Totalsave recovery system, or a comparable refrigerant recovery system. Refer to Service section, page 1.
2. Remove chassis from casing. See Chassis Removal instructions, above.
3. Remove air handling system. See Air Handling System Removal instructions, page 9.
4. Cut interconnecting tubing and remove evaporator coil from basepan by removing 2 evaporator screws. See Fig. 15.
5. Cut interconnecting tubing and remove condenser coil from basepan by removing 2 condenser coil screws. See Fig. 15.
6. Reverse above procedure for reassembly.



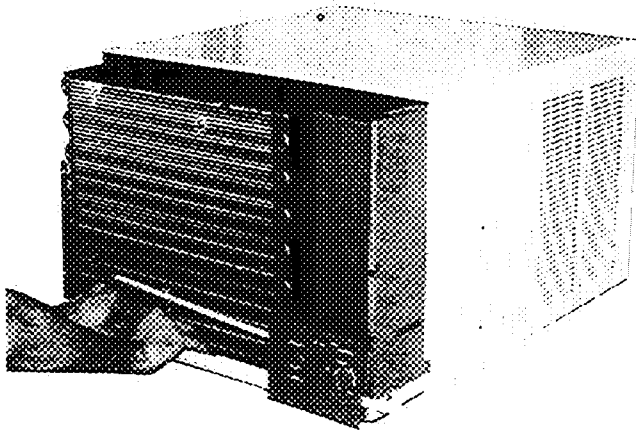

**Fig. 14 – Removing Chassis**

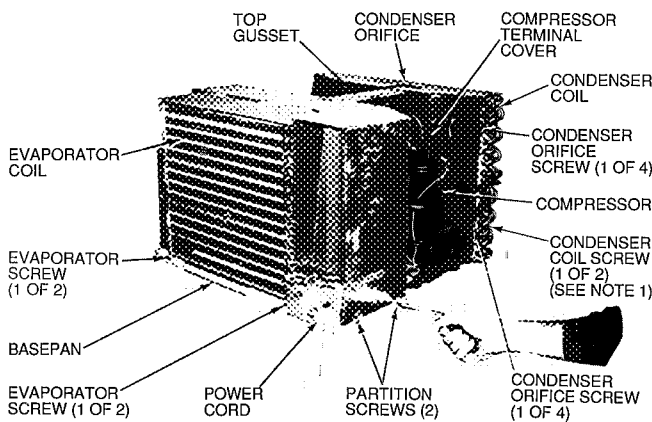

**NOTES:**

1. Second condenser coil screw is located on the back of unit.
2. Third and fourth condenser orifice screws are located in same area on opposite end of condenser orifice

**Fig. 15 – Unit Chassis**

**Air Handling System Removal**

1. Remove chassis from casing. See Chassis Removal instructions, page 8.
2. Remove 2 screws securing partition to basepan as shown in Fig. 15, and one screw on left side (Fig. 16), and one screw on rear side of partition (Fig. 17), in area of motor.
3. Remove 2 screws securing evaporator scroll to evaporator tube sheet. See Fig. 16.
4. Remove 4 screws (2 on right side and 2 on left side) securing condenser orifice to condenser coil tube sheet. See Fig. 15 for location of right-side screws; left-side (2) screws are in similar location on left side.
5. Remove compressor terminal cover. Disconnect wires from compressor and external overload protector terminals. Label wires to aid in reassembly. See Fig. 15.  
NOTE: Not all models have compressors with external overload protectors; certain models use compressors with internal overload protectors
6. Remove fan motor clip. See Fig. 17.

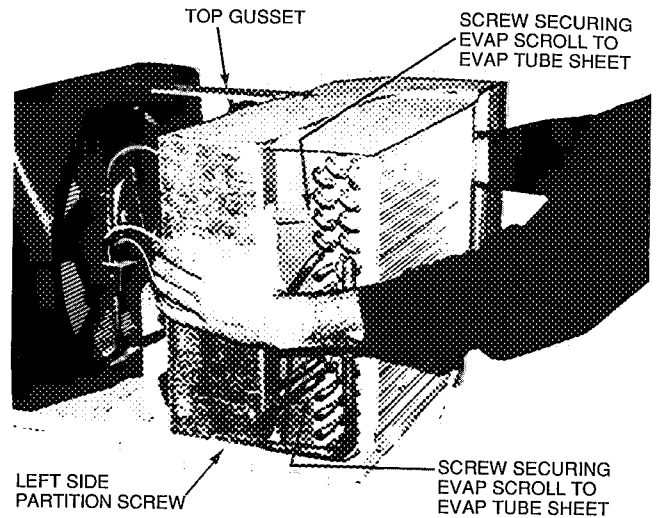

**Fig. 16 – Preparing to Lift Air Handling System**

7. Carefully disengage one of the vertical air deflectors, allowing access to assist in removing air handling system assembly. See Fig. 18.
8. Carefully lift assembly from chassis. See Fig. 19.
9. Reverse above procedure for reassembly, ensuring air handling system is positioned correctly. Tighten all screws.

**Exhaust Door Removal (See Fig. 20)**

1. Remove chassis from casing. See Chassis Removal instructions on page 8.
2. Remove air handling system. See Air Handling System Removal instructions, on this page.
3. Remove control box from chassis. See Control Box Removal instructions, page 5.
4. Remove 3 screws securing partition to indoor plastic scroll. (See Fig. 21.)
5. Carefully separate sheet metal partition slots from scroll tabs on both sides by spreading sheet metal sides apart. Remove scroll from sheet metal partition. (See Fig. 22.) Exhaust door and cable assembly from door to rotary knob (Fig. 20) are now exposed for required repairs or adjustments.
6. Reverse above procedure for reassembly.

**Vent Door Removal (Models 73YCA213P and 73YCA243P Only) (See Fig. 20)**

1. Remove chassis from casing. See Chassis Removal instructions, page 8.
2. Remove air handling system. See Air Handling System Removal instructions, on this page.
3. Remove control box from chassis. See Control Box Removal instructions, page 5.
4. Remove 3 screws securing center partition to indoor plastic scroll. See Fig. 21.
5. Carefully separate sheet metal partition slots from scroll tabs on both sides by spreading sheet metal sides apart. Remove scroll from sheet metal partition. See Fig. 22. Vent door and cable assembly from door to rotary knob (Fig. 20) are now exposed for repairs or adjustments.
6. Reverse above procedure for reassembly.

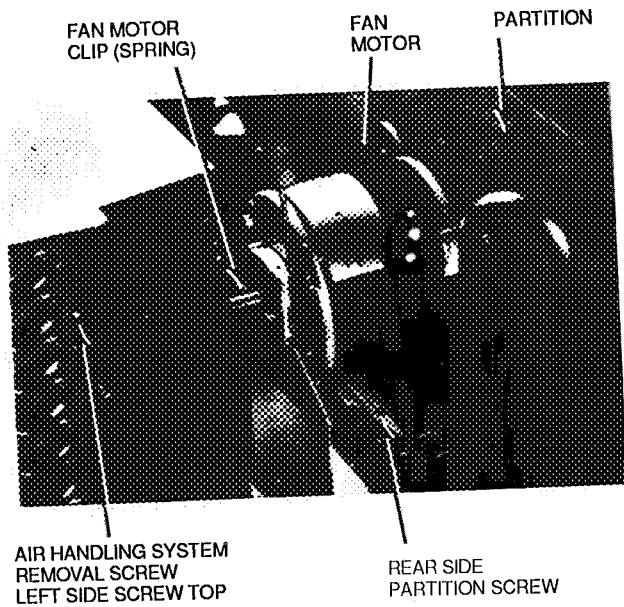

**Fig. 17 – Removing Fan Motor Clip**

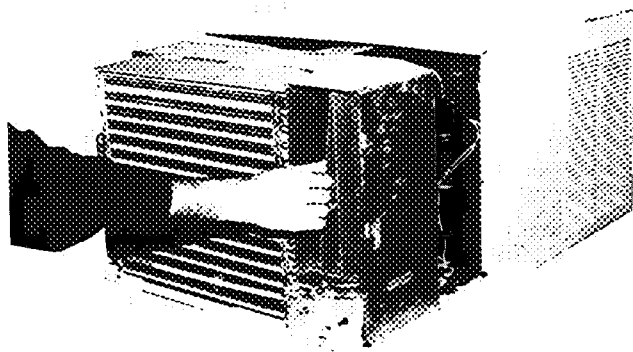

**Fig. 18 – Disengaging Vertical Air Deflector**

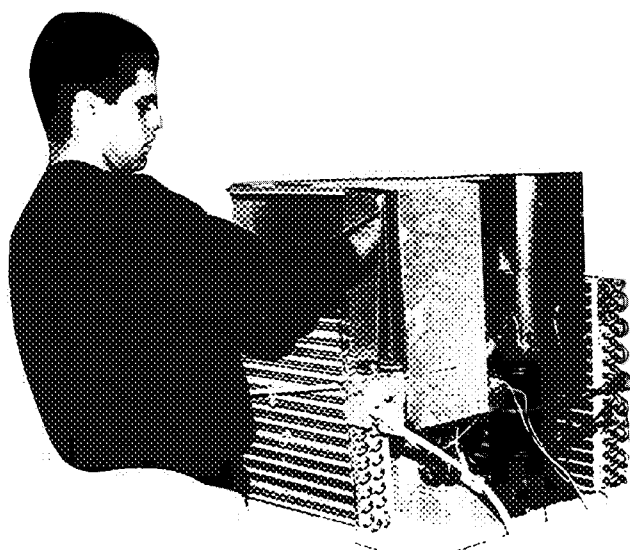

**Fig. 19 – Removing Air Handling System**

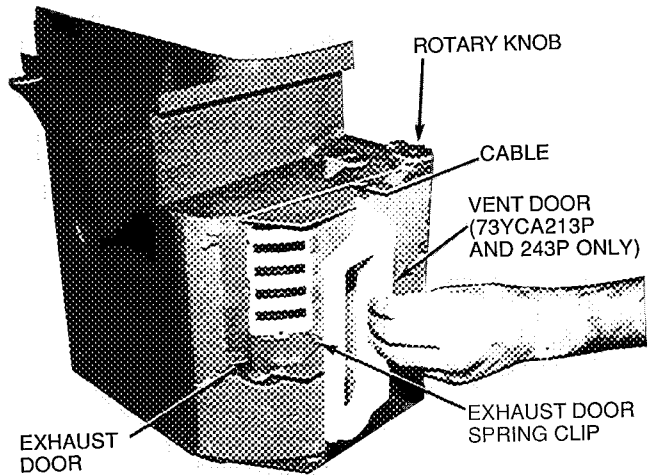

**Fig. 20 – Indoor Plastic Scroll Assembly**

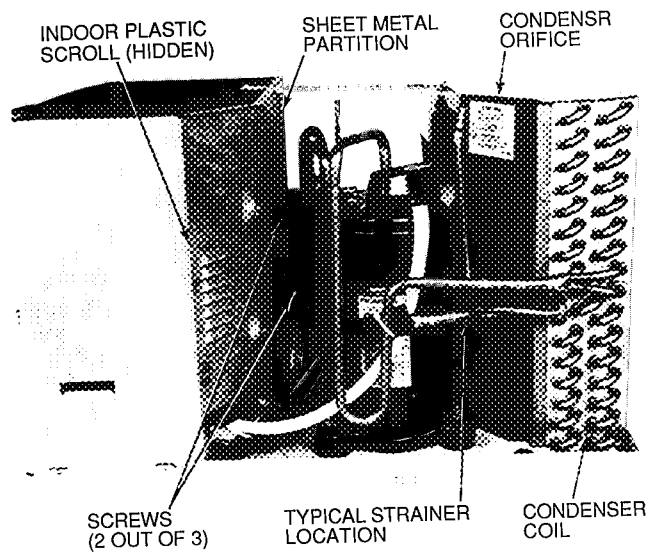

NOTE: Third screw is located on left side of partition as viewed from front of unit.

**Fig. 21 – Screws Securing Partition to Indoor Plastic Scroll Assembly**

**Indoor Blower Wheel Removal (See Fig. 22)**

1. Remove chassis from casing. See Chassis Removal instructions, page 8.
2. Remove air handling system. See Air Handling System Removal instructions, page 9.
3. Mark shaft at a point where wheel hub and motor shaft meet to aid in reassembly.
4. Remove spring metal clip from blower wheel hub. See Fig. 22.
5. Slide off blower wheel from motor shaft.
6. Reverse above procedure for reassembly.

**Outdoor Propeller Fan Removal (See Fig. 23)**

1. Remove air handling system. See Air Handling System Removal instructions, page 9.
2. Mark shaft at a point where fan hub and motor shaft meet to aid in reassembly.
3. Remove spring metal clip from fan hub. See Fig. 23.
4. Remove fan from motor shaft.
5. Reverse above procedure for reassembly.

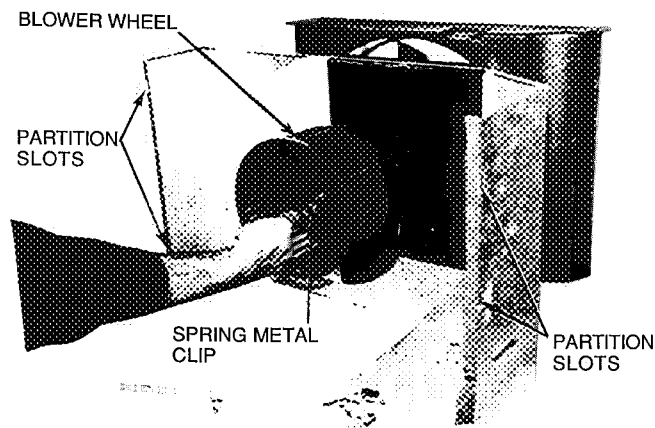

**Fig. 22 – Removing Blower Wheel**

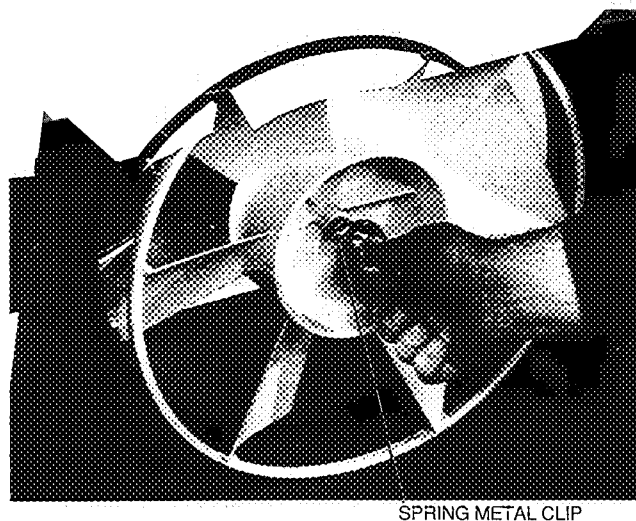

**Fig. 23 – Removing Outdoor Propeller Fan**

### Fan Motor Removal (See Fig. 24)

1. Remove chassis from casing. See Chassis Removal instructions, page 8.
2. Remove air handling system. See Air Handling System Removal instructions, page 9.

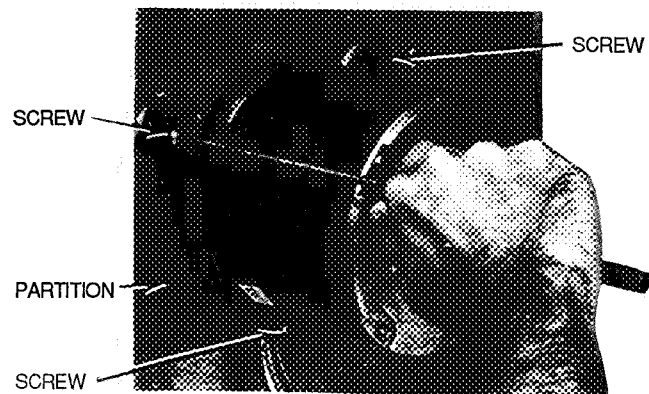

**Fig. 24 – Removing Fan Motor**

3. Remove indoor blower wheel and outdoor fan. See Indoor Blower Wheel Removal and Outdoor Propeller Fan Removal instructions, page 10.
4. Remove control box. See Control Box Removal instructions, page 5.
5. Carefully disconnect fan motor wiring.
6. Remove 3 screws securing motor to partition. See Fig. 24.
7. Reverse above procedure for reassembly.

### Compressor Removal (See Fig. 15)

NOTE: Before removing compressor, refer to Service section, page 1, and Carrier Standard Service Techniques Manual, Chapters 1 and 2.

1. Reclaim all refrigerant from system using a Carrier Totalclaim® or Carrier Totalsave recovery system, or a comparable refrigerant recovery system.
2. Remove chassis from casing. See Chassis Removal instructions, page 8.
3. Remove compressor terminal cover. (See Fig. 15.)
4. Disconnect wires from compressor and external overload protector terminals. Label wires to aid in reassembly.

NOTE: Some models may have compressors with internal overload protectors.

5. Replace external overload protectors, if needed.
6. Disconnect piping. Refer to Compressor Replacement section, page 2, being careful to observe all CAUTIONS.

### Strainer Removal and Replacement

NOTE: Two strainers are installed in the interconnecting tubing: one is between the condenser and capillary tube, and one is between the evaporator and capillary tube. (For typical location, see Fig. 21.)

1. Remove chassis from casing. See Chassis Removal instructions, page 8.
2. Reclaim all refrigerant from system using a Carrier Totalclaim or Carrier Totalsave recovery system, or a comparable system. Refer to Service section, page 1.
3. Cut tubing 1 in. from capillary tube insertion point.
4. Use a thin piece of wire to remove strainer from tubing.
5. Insert new strainer into tubing. Reassemble tubing with field-supplied copper coupling.

### Electric Heater Assembly Removal

1. Remove chassis from casing. See Chassis Removal instructions, page 8.
2. Remove plastic access cover on top of partition. (See Fig. 25.)
3. Remove heater assembly (Fig. 26) by lifting straight up, taking care not to cause fin damage to top of evaporator coil when heater assembly mounting bracket is lifted off coil.
4. Remove 2 wires from heater assembly (Fig. 25). Mark wires to aid in reassembly.
5. Repair or replace limit switches (Fig. 26) as needed.
6. Reverse above procedure for reassembly.

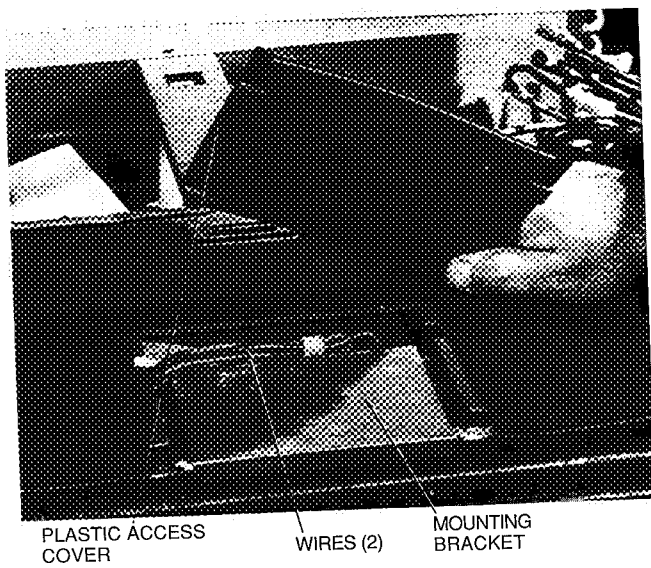

**Fig. 25 – Heater Assembly Wires**

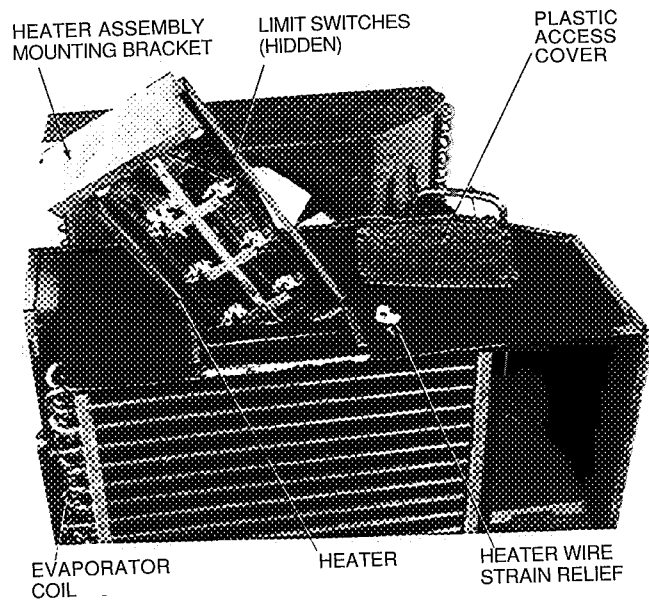

**Fig. 26 – Chassis with Electric Heater**

## **SERVICE POINTS (Check Annually)**

1. Clean evaporator and condenser coils.  
Indoors — Use a hooked wire or bristle brush to remove dirt from fins.  
Outdoors — Use compressed air or a vacuum cleaner.
2. Clean basepan and other painted surfaces.
3. Clean all drain passages.
4. Clean motor and fans.
5. Vacuum clean the insulation.
6. Paint parts that show evidence of rust with a good rust-resistant paint.
7. Check refrigerant connections for evidence of leakage. Repair if necessary.
8. Check wires for deterioration.
9. Check damper controls.
10. Fans should be tight on motor shaft.
11. Run the unit and eliminate any piping vibration.
12. Check thermostat capillaries for proximity to refrigerant tubing (should not be touching). Check to be sure protective sleeve is in place.

## TROUBLESHOOTING

SYMPTOM AND PROBABLE CAUSE	PROBABLE REMEDY
<b>COMPRESSOR DOES NOT RUN</b> Opening in Power Circuit 1. Control off 2. Blown fuse 3. Defective wiring 4. Defective service cord 5. Loose electrical connections 6. Faulty switches, thermostat, or fan	1. Reset control button 2. Replace fuse. 3. Replace wiring. 4. Replace service cord 5. Tighten connections. 6. Replace defective component.
<b>Compressor Power Supply Open</b> 1. Loose leads at compressor terminals 2. Defective motor overload switch 3. Defective capacitor 4. Open compressor windings 5. Seized compressor	1. Tighten leads. 2. Replace switch 3. Replace capacitor 4. Replace compressor 5. Replace compressor
<b>COMPRESSOR RUNS BUT CYCLES</b> Fan Operating Erratically 1. Loose lead at fan motor 2. Defective or burned out motor 3. Outdoor air restricted or recirculating  4. Overcharge or noncondensables in system  5. Restricted discharge line 6. Defective motor overload switch	1. Tighten lead 2. Repair or replace motor 3. Check for dirty filter, proper clearances around unit — remove any obstructions 4. Reclaim refrigerant, evacuate and recharge system according to nameplate specifications. 5. Check for obstruction in line, replace tubing if required. 6. Replace switch.
<b>Cycles on Compressor Overload</b> 1. Defective run capacitor 2. Defective compressor bearings or valves 3. Greatly restricted indoor air (iced indoor coil) 4. Low refrigerant charge 5. Indoor capillary restricted 6. Liquid line restricted 7. Compressor hot 8. Weak or inconsistent line power	1. Replace capacitor. 2. Replace compressor 3. Defrost indoor coil. 4. Add charge according to approved method. 5. Replace capillary. 6. Replace strainer 7. Verify refrigerant charge. 8. Check line voltage at time of compressor start-up
<b>INSUFFICIENT COOLING</b> Cooling Air Not Adequate 1. Dirty filter or coil 2. Iced indoor coil (slightly low refrigerant charge) 3. Defective fan motor	1. Clean as required 2. Recharge. 3. Replace fan motor.
<b>Condenser Air Not Adequate</b> 1. Outside air restricted 2. Dirty coil 3. Defective fan motor	1. Check for obstructions and dirty filter. Remedy as required. 2. Clean coil. 3. Replace fan motor.
<b>Unit Undersized</b>	Re-evaluate unit for proper capacity
<b>Air Leakage</b>	Check caulking around sleeve Repair if necessary.
<b>Capillary Restricted</b>	Replace capillary.
<b>Compressor Flooding</b> 1. Unit overcharged  2. Low indoor airflow	1. Reclaim refrigerant, evacuate and recharge system according to nameplate specifications. 2. Clean filter and/or evaporator coil
<b>AIR SWEEP NOT WORKING</b> 1. Linkage in upper control box stuck 2. Air sweep motor failure	1. Lubricate linkage. Check for proper assembly 2. Replace motor
<b>HEATER CYCLES ON LIMIT SWITCH</b> 1. Dirty filter 2. Blocked indoor air inlet 3. Low airflow due to fan motor speed	1. Clean or replace filter 2. Remove blockage. 3. Check fan motor. Repair or replace as necessary.

